

SPEC NO.	SP03AF24427-030	ISSUED DATE	96.11.19	PUBLISHED BY
PRODUCT NAME	PPA 2442F	VERSION	03	
		PAGE	2/14	

CIROCOMM TECHNOLOGY .

PART NUMBER :03A40B2A00K9110

1 SCOPE

This specification covers the dielectric PIFA antenna for **2400-2500 MHz** .

2 Name of the product

This product is named “Dielectric PIFA Antenna” .

3 Electrical characteristics

3-1 Electrical characteristics of antenna

The antenna has the electrical characteristics given in Table 1 under the *cirocomm* standard installation conditions shown in the figure of Evaluation Board.

Table 1

No	Parameter	Specification
1	Range Of Receiving Frequency	2400-2500 MHz
2	Center Frequency	2810±20MHz
3	Return Loss	< -10dB
4	Bandwidth	>120MHz @-7.35dB
5	VSWR	2.0 max
6	Polarization	Linear
7	Operating temperature	-40°C to +105 °C
8	Impedance	50 Ω

* Actual value will depend on customer ground plane size



SPEC NO.	SP03AF24427-030	ISSUED DATE	96.11.19	PUBLISHED BY
PRODUCT NAME	PPA 2442F	VERSION	03	
		PAGE	3/14	

S11 Response curve

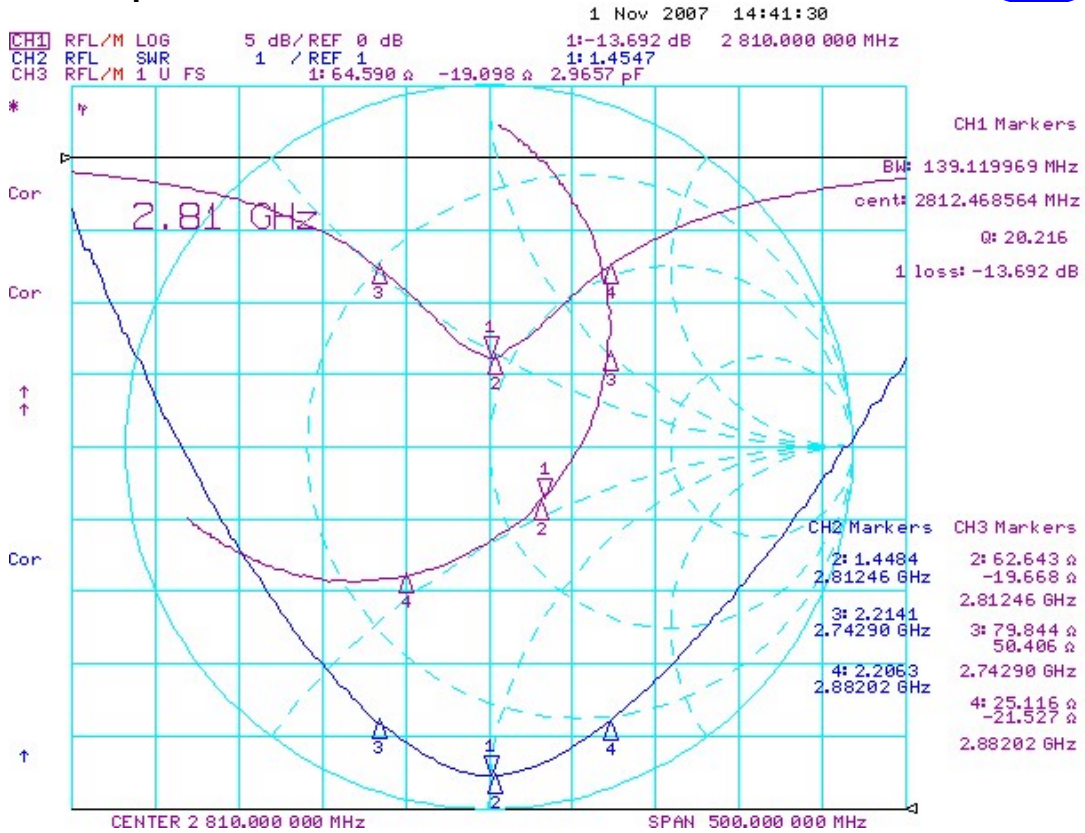

Gain Data

- * Gain is measured at CIROCOMM PCB (40*80*0.8)
- * Ant position: Right side, horizontal

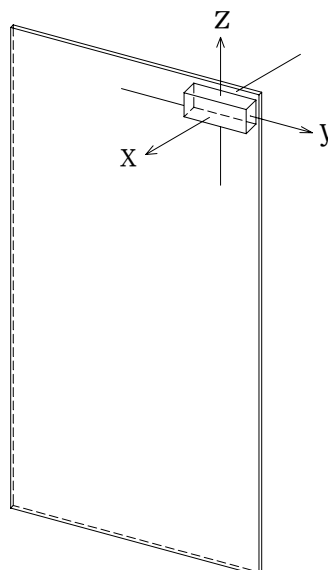

SPEC NO.	SP03AF24427-030	ISSUED DATE	96.11.19	PUBLISHED BY
PRODUCT NAME	PPA 2442F	VERSION	03	
		PAGE	4/14	

Gain and Efficiency

	Frequency (GHz)	Peak Gain (dBi)	Efficiency (%)
1	2.400	-2.01	32.64
2	2.442	-1.39	35.78
3	2.450	-1.37	35.40
4	2.4835	-2.07	29.48
5	2.500	-2.37	27.89

Power average gain

	Frequency (GHz)	Plane	Average Gain (dBi)
1	2.400	XY plane	-5.737
		YZ plane	-5.918
		XZ plane	-4.654
2	2.442	XY plane	-5.437
		YZ plane	-5.427
		XZ plane	-4.279
3	2.450	XY plane	-5.483
		YZ plane	-5.538
		XZ plane	-4.308
4	2.4835	XY plane	-6.349
		YZ plane	-6.419
		XZ plane	-5.186
5	2.500	XY plane	-6.616
		YZ plane	-6.717
		XZ plane	-5.429

SPEC NO.	SP03AF24427-030	ISSUED DATE	96.11.19	PUBLISHED BY
PRODUCT NAME	PPA 2442F	VERSION	03	
		PAGE	5/14	

Antenna Pattern For Blue Tooth

Frequency : 2.400 GHz

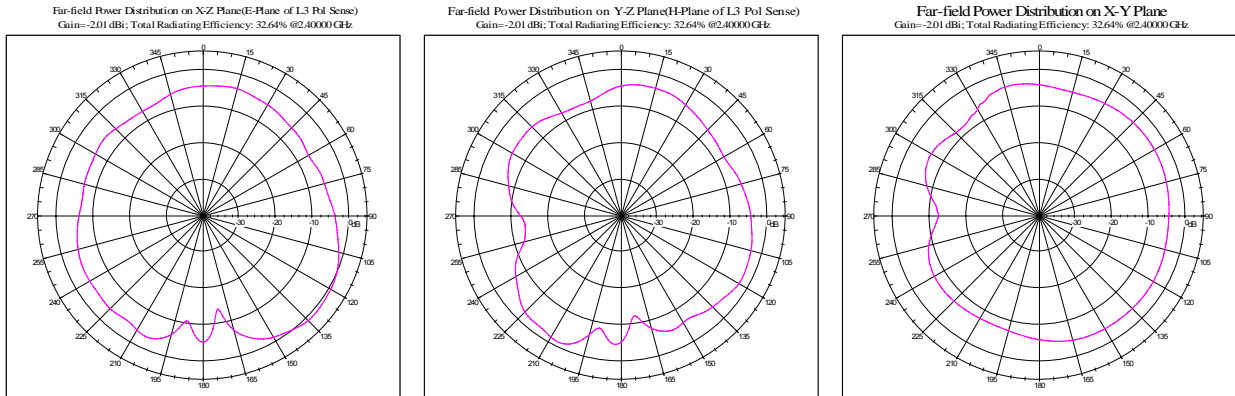

Frequency : 2.442 GHz

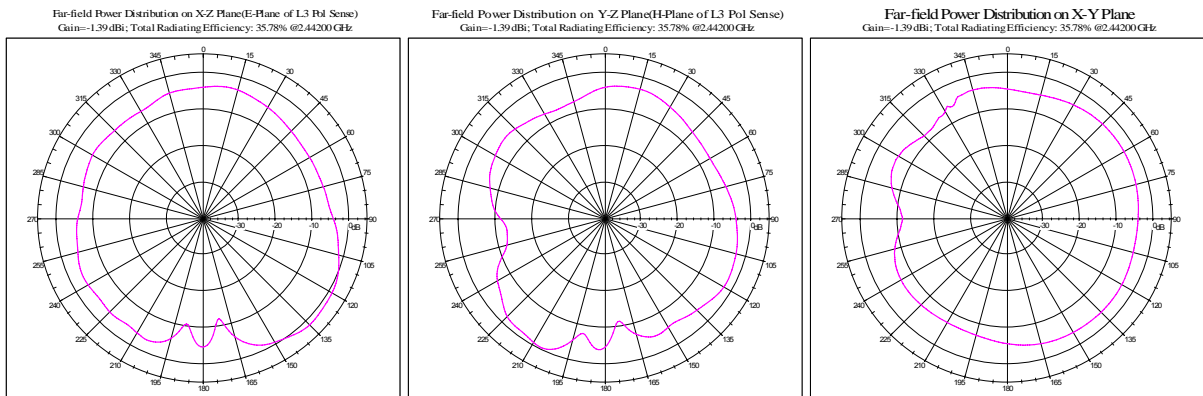

Frequency : 2.450 GHz

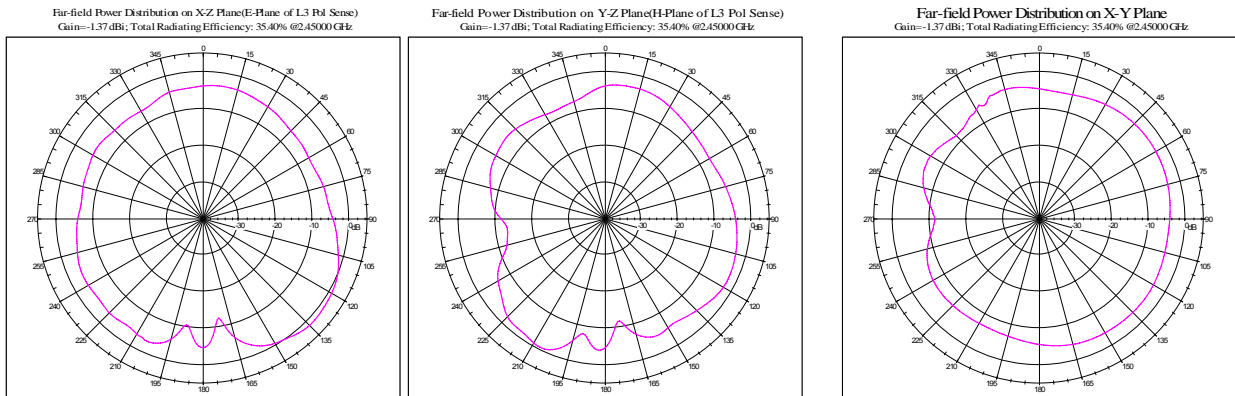

SPEC NO.	SP03AF24427-030	ISSUED DATE	96.11.19	PUBLISHED BY
PRODUCT NAME	PPA 2442F	VERSION	03	
		PAGE	6/14	

Frequency : 2.4835 GHz

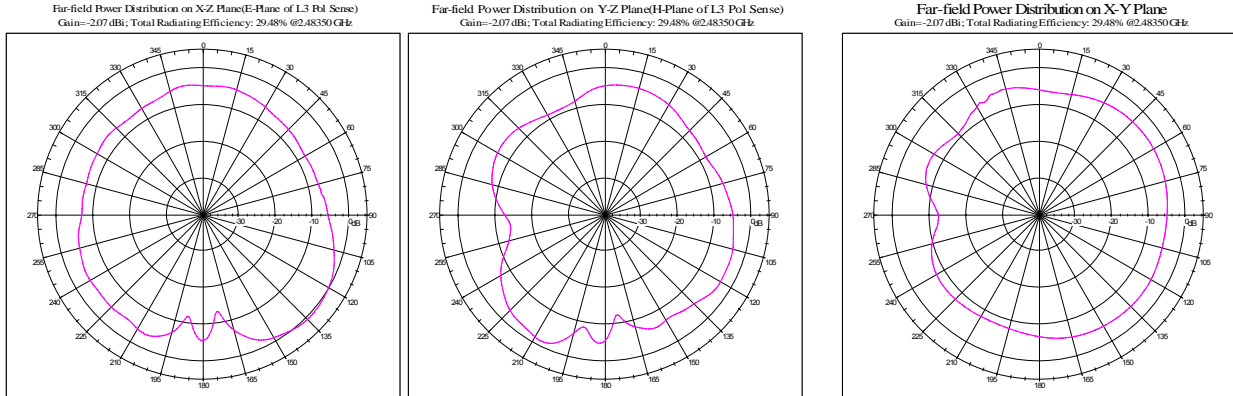

Frequency : 2.500 GHz

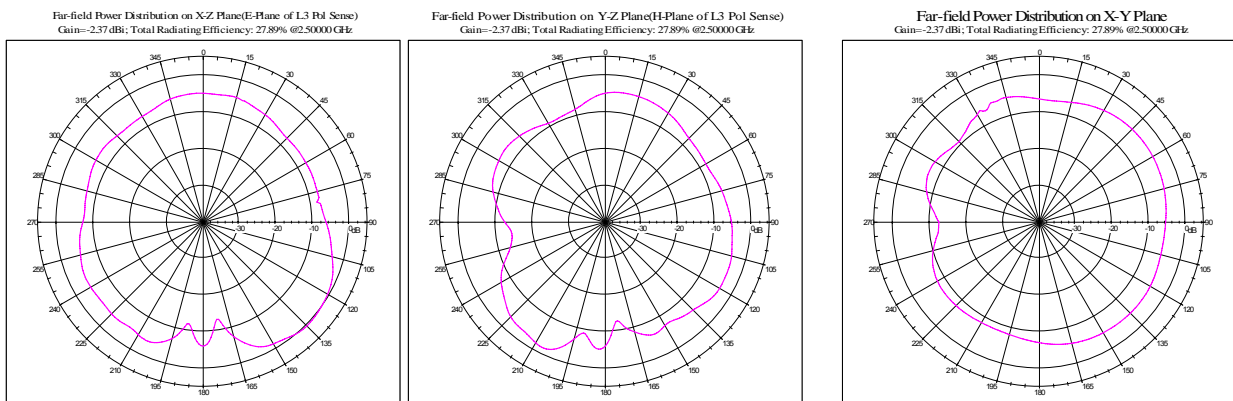

4 Environmental conditions

4-1 Operating conditions

The antenna has the electrical characteristics given in Tables 1 in the temperature range of -40°C to $+105^{\circ}\text{C}$ and under the environmental conditions of $+40^{\circ}\text{C}$ and 0-95% r.h..

4-2 Storage temperature range

The storage temperature range of product is -40°C to $+105^{\circ}\text{C}$

5 Reliability tests

5-5-2 and 5-6 examination of enforced. Moreover, the decision standard of the movement confirmation is judged by 3 and 4 of the tables-1, and the decision standard of the appearance isn't thought function problem become defect be.



SPEC NO.	SP03AF24427-030	ISSUED DATE	96.11.19	PUBLISHED BY
PRODUCT NAME	PPA 2442F	VERSION	03	
		PAGE	7/14	

The decision standard of the confirmation of the movement is doing the characteristic electric standard of the antenna module. And, the decision standard of the appearance isn't thought function problem become defect be.

5-1. Low-temperature test

Expose the specimen to -30°C for 500 hours and then to normal temperature/humidity for 24 hours or more. After that examine the appearance and functions.

5-2 High-temperature test

Expose the specimen to $+85^{\circ}\text{C}$ for 500 hours and then to normal temperature/humidity for 24 hours or more. After that examine the appearance and functions.

5-3 High-temperature/high-humidity test

Subject the object to the environmental conditions of $+85^{\circ}\text{C}$ and 90-95% r.h. for 96 hours, then expose to normal temperature/humidity for 24 hours or more. After this, check the appearance and functions.

5-4 Thermal shock test

Subject the object to cyclic temperature change (-30°C , 30 minutes \leftrightarrow $+85^{\circ}\text{C}$, 30 minutes) for 5 cycles, then expose to normal temperature/humidity for 24 hours or more.

5-5 Vibration test

5-5-1 Sinusoidal vibration test

Subject the object to vibrations of 5 to 200 to 5Hz swept in 10 minutes, 4.5G at maximum (2mm amplitude), in X and Y directions for two hours each and in Z direction for four hours. After this, check the appearance functions.

5-5-2 Vibration test in packaged condition

Subject the object, which is packaged as illustrated, to vibrations of 15 to 60 to 15Hz swept in 6 minutes, 4G at maximum (2mm amplitude at maximum), applied in X, Y and Z directions for two hours each, i.e. six hours in total. After this, check the appearance and functions.

5-6 Free fall test in packaged condition

Drop the object, which is packaged as illustrated, to a concrete surface from the height of 90 cm, on one corner, three edges and six faces once each, i.e. 10 times in total. After this, check the appearance and functions.

5-7. Soldering Heat Resistance Test:

After the lead pins of the unit are soaked in solder bath at $270 \pm 5^{\circ}\text{C}$ for 10 ± 0.5



SPEC NO.	SP03AF24427-030	ISSUED DATE	96.11.19	PUBLISHED BY
PRODUCT NAME	PPA 2442F	VERSION	03	
		PAGE	8/14	

seconds and then be left for more than 1 hour at $25\pm 5^{\circ}\text{C}$ in less than 65% relative humidity.

5-8. Adhesion Test:

The device is subjected to be soldered on test PCB. Then apply 0.5Kg(5N) of force for 10 ± 1 seconds in the direction of parallel to the substrate. (the soldering should be done by reflow and be conducted with care so that the soldering is uniform and free of defect by stress such as heat shock) .

6 Inspection

As for the examination in the mass production, the receiving character of the ratio wave sent in a shield box from the standard antenna and VSWR are confirmed in the picking out examination.

7 Warranty

If any defect occurs form the product during proper use within a year after delivery, it will be repaired or replaced free of charge.

8 Other

Any question arising from this specification manual shall be solved by arrangement made by both parties.

9 Precautions for use

- Antenna pattern use a Ag electrode.
- Please don't use the corrosion gas (sulfur gas, chlorine gas) in the atmosphere.
- Please don't direct solder onto the gold electrode of Antenna pattern.



SPEC NO.	SP03AF24427-030	ISSUED DATE	96.11.19	PUBLISHED BY
PRODUCT NAME	PPA 2442F	VERSION	03	
		PAGE	9/14	

10. Drawings

Shape and Dimension

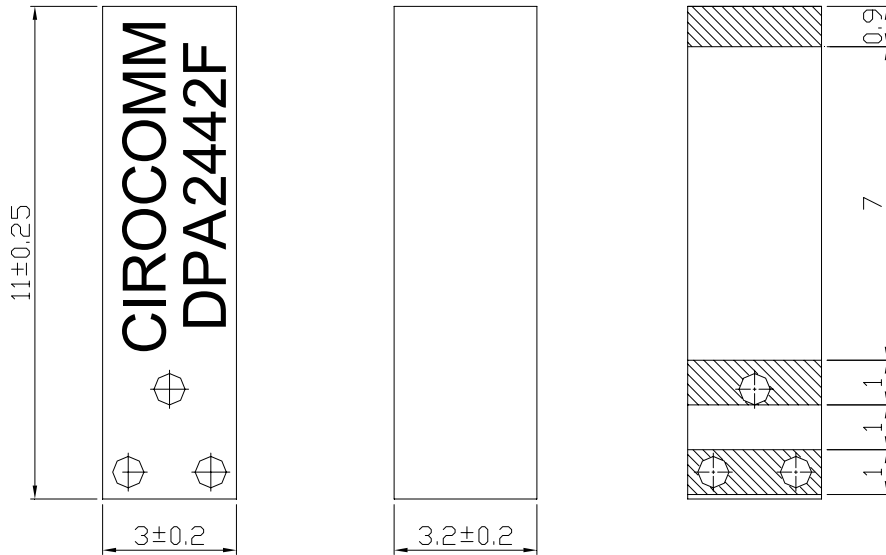

Recommend foot print for Evaluation Board

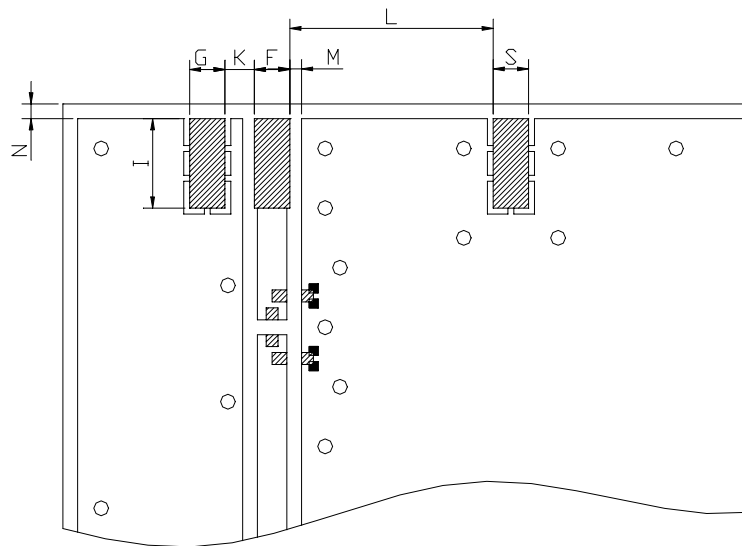

Copper area
 Soldering pads
 Transparent area

G	F	S	I	K	L	M	N
Ground	Feed	Solder					
1.0±0.1	1.0±0.1	0.9±0.1	3±0.1	1.0±0.1	7.0±0.2	0.4±0.1	0.5±0.1
Dimensions in millimeter							



SPEC NO.	SP03AF24427-030	ISSUED DATE	96.11.19	PUBLISHED BY
PRODUCT NAME	PPA 2442F	VERSION	03	
		PAGE	10/14	

Delivery mode

1. Pieces/tape : 1000

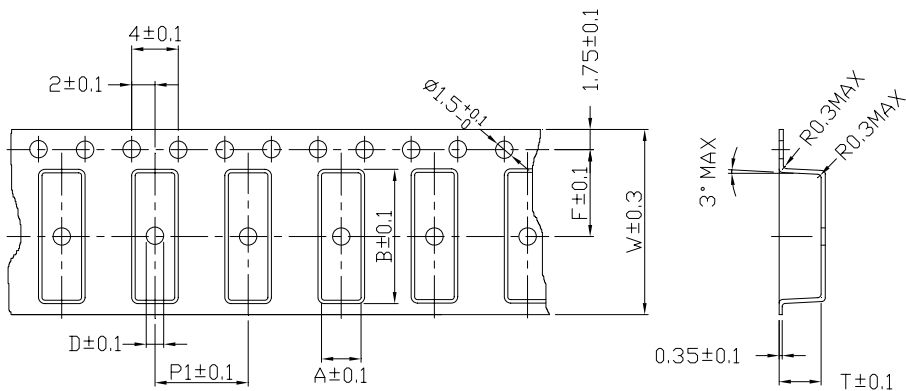
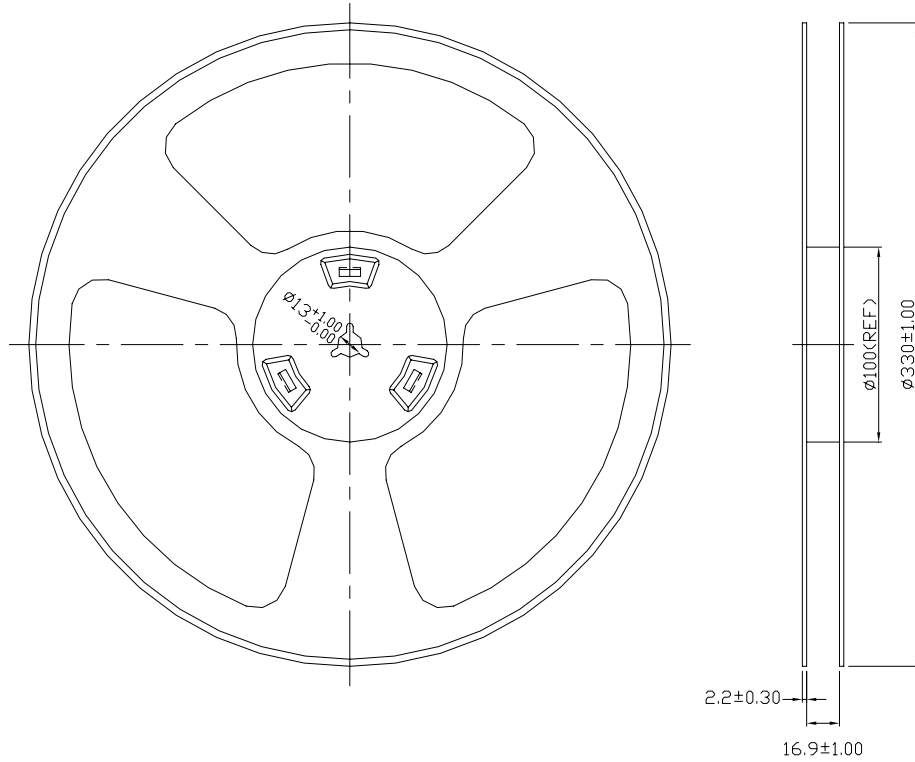

No	Index	Spec.(mm)
1	A	3.4
2	B	11.4
3	P1	8
4	W	16
5	F	7.5
6	T	3.6
7	D	1.5



SPEC NO.	SP03AF24427-030	ISSUED DATE	96.11.19	PUBLISHED BY
PRODUCT NAME	PPA 2442F	VERSION	03	
		PAGE	11/14	

FAQ:

1.What is radio wave?

Radio waves are waves produced by the interaction of time -varying electric and magnetic fields. More properly they are referred to as electromagnetic waves. With the Wireless Telegraphy Act it was decided that all electromagnetic waves with a frequency below 3,000GHz would be called radio waves.

2. What is antenna?

An antenna converts electrical energy to radio waves and transmits them into the sky as well as collecting radio waves from the sky and converting them to electrical energy.

3.What is good antenna (1)?

As antenna serves as the electrical power conversion device between a circuit and the air, the keys to it's efficiency are as follows:

- (1) Input characteristics with the contact point on the circuit side
- (2) Radiation characteristics from the contact point to the air

Input Characteristics

Electric power is supplied efficiently to the antenna without reflecting back into the circuit at the feeding point

> If the impedance between the antenna and the feed line is not matched correctly, the signal will reflect back and no power will be supplied to the antenna.

Radiation Characteristics

The power supplied to the antenna is not lost within the antenna but is transmitted as a radio wave.

> If the antenna is made of high loss material (conductors and dielectrics), then the power that was supplied to the antenna will be dissipated into heat and lost.

4. What is good antenna (2)?

The characteristics of a general antenna are shown below.

(1) Input Characteristics

Frequency - Return loss chart ...where the return loss is low, indicates that the antenna is Frequency – VSWR chartwell matched at that frequency. In the same way, a low value shows a good matching of the antenna.

* Bandwidth ... The antenna is good to the extent of good matching and the width of the frequency domain.

(2) Radiation Characteristics

Radiation pattern ...The strength of the antenna emission is displayed.

It shows that antennas emit well in their projected direction.



SPEC NO.	SP03AF24427-030	ISSUED DATE	96.11.19	PUBLISHED BY
PRODUCT NAME	PPA 2442F	VERSION	03	
		PAGE	12/14	

It is usually displayed in three planes (XY, YZ and ZX planes).

Gain [dBd] Given as a ratio to a standard antenna (half wave dipole).

Usually displayed as the average of the three planes (XY, YZ and ZX planes).

Designated as a combination of the vertical and horizontal polarity power gains.

5. Importance of tuning?

Because many things, such as the board shape, surrounding components and the case covering the board, can affect the characteristics of an antenna, most designs require customization of the antenna to compensate for the shift in characteristics. Correcting the shift in the characteristics of the antenna is known as tuning. For this work, having lots of experience from adjusting many items and equipment is where an antenna maker can really show their strengths.

This experience can really help the user in getting the help needed for a quick product design.

6. Our workflow for tuning?

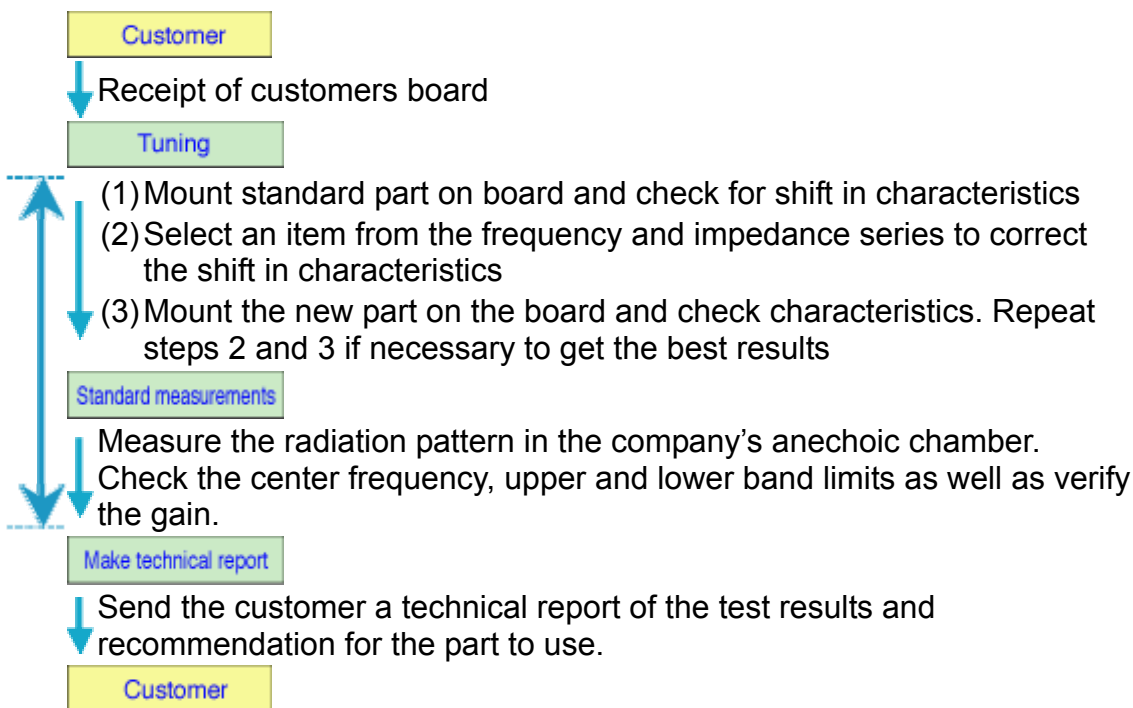

SPEC NO.	SP03AF24427-030	ISSUED DATE	96.11.19	PUBLISHED BY
PRODUCT NAME	PPA 2442F	VERSION	03	
		PAGE	13/14	

7. Why can we response so quickly?

(1) We have anticipated the characteristic shifts and created a series of parts that match those shifts and corrects them.

- Frequency Series Parts

When an antenna is mounted, the center frequency will shift due to surrounding elements. These parts will bring that frequency back to the proper center frequency. There are 18 values available in 29MHz steps.

- Impedence Series Parts

The impedance of an antenna will appear different depending on the shape of the board and other items surrounding the antenna. Normally in these situations, designers will make a matching circuit by adding capacitors or inductors, we however have created antennas with 3 different impedances values, so a standard antenna can be quickly matched to the design without any modifications to the circuit.

(2) Complete Measurement Environment

Our facilities are complete with a full anechoic chamber and all required test equipment for quick and complete testing.

(2) Standard Data Reporting

Using standardized data forms, the information can quickly be assembled into a report.

* If a verbal reply is sufficient, we can reply within 2 days of receiving the customer's board.

8. How to select the correct antenna?

It is important to select the correct antenna for the application.

1) Important Information about Small Antennas!

As for chip antennas, you must consider the ground plane surrounding the area the chip is mounted. When using a small antenna it is often necessary to make a large ground plan to improve the characteristics of the antenna, the results is a larger area on the board for the antenna. Also, since small antennas typically are $\lambda/4$ type antennas, a large GND is also important. In fact if the GND is not large enough, there are some small antennas that will not operate.

> We consider the ground plane area in addition to the area for mounting antenna as a set, and can propose the optimum configuration for both.

Also, if there is room in your design, the larger antenna you can use the better off you will be. (It has been theoretically proven that as an antenna becomes smaller the performance deteriorates.)

2) Use Directivity Appropriately!

When you know the direction of the transmission, you should choose to use a directional antenna. If you don't, you will scatter the radio waves and the power will be wasted.

Also, as seen in the recent case with SAR, directional antennas were best to effectively isolate the body.

> We have both directional and omni directional antennas, so please



SPEC NO.	SP03AF24427-030	ISSUED DATE	96.11.19	PUBLISHED BY
PRODUCT NAME	PPA 2442F	VERSION	03	
		PAGE	14/14	

consider what are best for your application.

3) Pitfall of Broadband Antennas!

For return loss characteristics, the loss amount is a combination of the transmission power and the power lost. Even in the case where the power loss is great and there is no transmission at all, the antenna may be seen as having very good broadband characteristics. To best judge the band, the gain's frequency characteristics should be judged.

> The standard data we submit then is the average gain for the necessary frequency.

4) Losses for the Matching Circuit!

This circuit is used to match the impedance at the feed of the antenna. In actuality, this circuit is also the primary cause of power loss. In addition, this circuit takes up additional space on the board, adding to the total area required for the antenna. If however, the antenna's impedance is matched with the characteristic impedance from the beginning, there is no need for this circuit.

> We do not use matching circuits, but instead have the ability to tune the antenna to match the impedance.